

FR2A~FR2M

FAST RECOVERY PLASTIC RECTIFIER

VOLTAGE 50 to 1000 Volt **CURRENT** 2 Ampere

SMB / DO-214AA Unit:mm

FEATURES

- Low Forward Voltage Drop
- Glass Passivated Junction
- High Current Capability
- Moisture Sensitivity Level 1
- Lead free in compliance with EU RoHS 2.0

MECHANICAL DATA

- Case Material: Molded Plastic.
- UL Flammability Classification Rating 94V-0

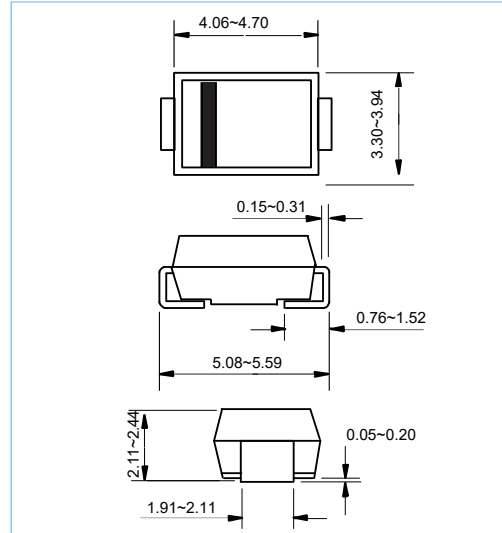
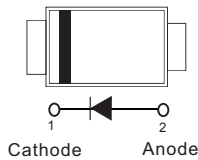

MAXIMUM RATINGS AND ELECTRICAL CHARACTERISTICS

Ratings at 25°C ambient temperature unless otherwise specified.

PARAMETER	SYMBOL	FR2A	FR2B	FR2D	FR2G	FR2J	FR2K	FR2M	UNITS
Maximum Recurrent Peak Reverse Voltage	V_{RRM}	50	100	200	400	600	800	1000	V
Maximum RMS Voltage	V_{RMS}	35	70	140	280	420	560	700	V
Maximum DC Blocking Voltage	V_{DC}	50	100	200	400	600	800	1000	V
Maximum Average Forward Current (see FIG.1)	$I_{F(AV)}$	2							A
Peak Forward Surge Current : 8.3ms single half sine-wave superimposed on rated load	I_{FSM}	50							A
Maximum Forward Voltage at 2 A	V_F	1.3							V
Maximum DC Reverse Current at Rated DC Blocking Voltage $T_J=25^{\circ}C$ $T_J=125^{\circ}C$	I_R	5 100							uA
Maximum Reverse Recovery Time(Note 1)	t_{rr}	150					250	500	ns
Thermal Resistance	$R_{\theta JL}$	30							$^{\circ}C / W$
Typical Junction Capacitance (Note2)	C_J	15							pF
Operating Junction Temperature Range	T_J	-55 to +150							$^{\circ}C$
Storage Temperature Range	T_{STG}	-55 to +150							$^{\circ}C$

NOTES:

1. Reverse Recovery Test Conditions: $I_F=0.5A, I_R=1.0A, I_{rr}=0.25A$
2. Measured at 1.0MHz and applied reverse voltage of 4.0 volt

FR2A~FR2M

RATING AND CHARACTERISTIC CURVES

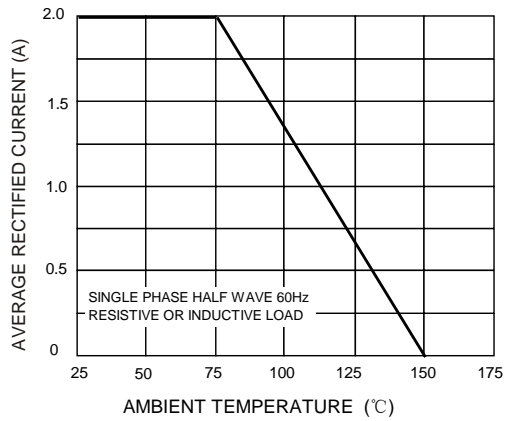

Fig. 1 Forward Current Derating Curve

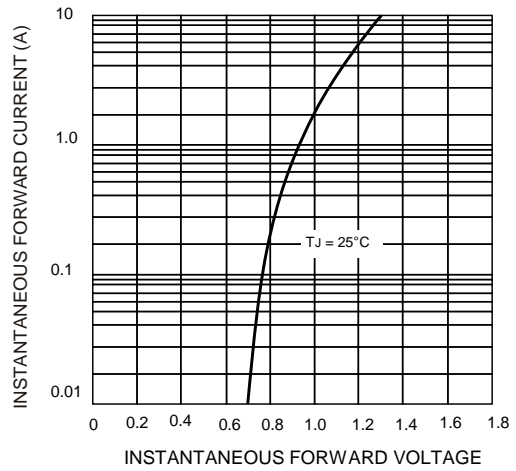

Fig. 2 Typical Forward Characteristics

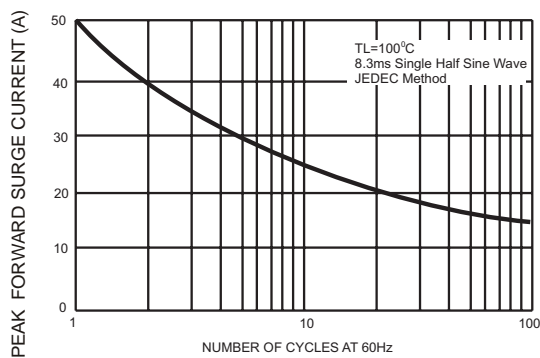

Fig. 3 Forward Surge Current Derating Curve

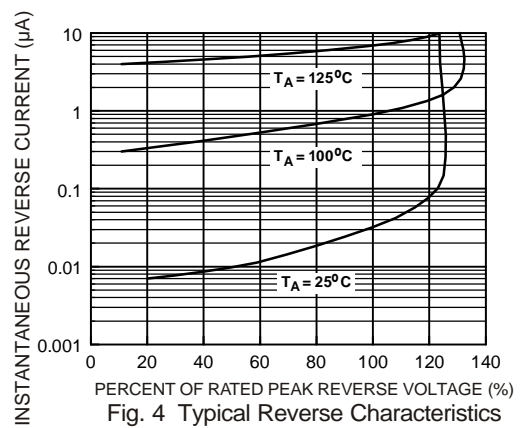

Fig. 4 Typical Reverse Characteristics

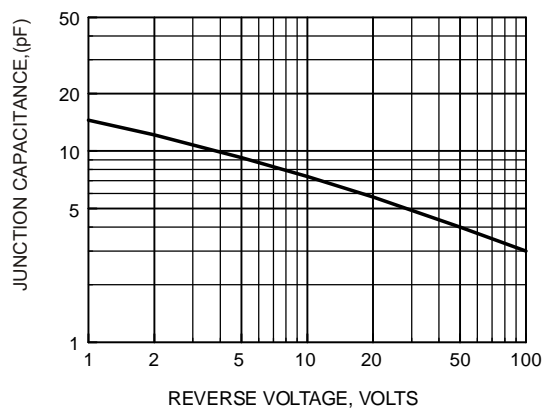

Fig. 5 Typical Junction Capacitance

FR2A~FR2M

MOUNTING PAD LAYOUT

SMB / DO-214AA

Unit:Inch(mm)

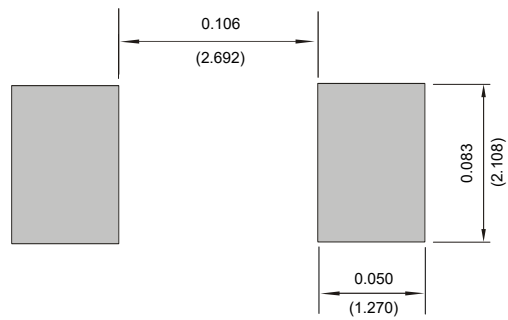

ORDER INFORMATION

- Packing information

Part Number	Case	Reel Size	QUANTITY
FR2A~FR2M	SMB	13 Inch	3000