

BAS21WS

SWITCHING DIODE

| | | | |
|----------------|-----------------|--------------|---------------|
| VOLTAGE | 250 Volt | POWER | 200 mW |
|----------------|-----------------|--------------|---------------|

SOD-323 Unit:mm

FEATURES

- Fast Switching Speed
- For General Purpose Switching Applications
- Lead free in compliance with EU RoHS
- Marking code: JS

MECHANICAL DATA

- Case Material: Molded Plastic.
- UL Flammability Classification Rating 94V-0

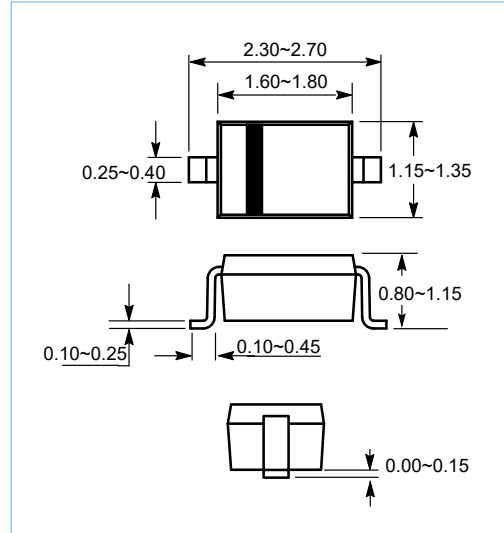
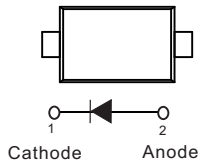

MAXIMUM RATINGS AND ELECTRICAL CHARACTERISTICS($T_A = 25^\circ\text{C}$ unless otherwise noted)

| Parameter | Symbol | Limit | Unit |
|--|-----------------|----------|--------------------|
| Peak Repetitive Peak Reverse Voltage | V_R | 250 | V |
| Peak Forward Current | I_F | 200 | mA |
| Repetitive peak forward surge current | I_{FRM} | 0.625 | A |
| Power Dissipation | P_d | 200 | mW |
| Thermal Resistance Junction to Ambient | $R_{\theta JA}$ | 625 | $^\circ\text{C/W}$ |
| Junction Temperature | T_j | 150 | $^\circ\text{C}$ |
| Storage Temperature | T_{STG} | -55~+150 | $^\circ\text{C}$ |

ELECTRICAL CHARACTERISTICS($T_A = 25^\circ\text{C}$ unless otherwise noted)

| Characteristic | Symbol | Conditions | Min | Typ | Max | Unit |
|-----------------------|------------|---|-----|-----|--------------|---------------|
| Reverse voltage | $V_{(BR)}$ | ($I_R = 100 \mu\text{A}$) | 250 | | | V |
| Reverse current | I_R | ($V_R = 200 \text{V}$) | | | 0.1 | μA |
| Forward Voltage | V_F | ($I_F = 100 \text{mA}$) ($I_F = 200 \text{mA}$) | | | 1.00 1.25 | V |
| Total Capacitance | C_T | ($V_R = 0 \text{V}$, $f = 1.0 \text{MHz}$) | | | 5.0 | pF |
| Reverse Recovery Time | t_{rr} | $I_F=30\text{mA}$, $I_R=30\text{mA}$, $R_L=100 \Omega$ | | | 50 | ns |

BAS21WS

Typical Characteristics

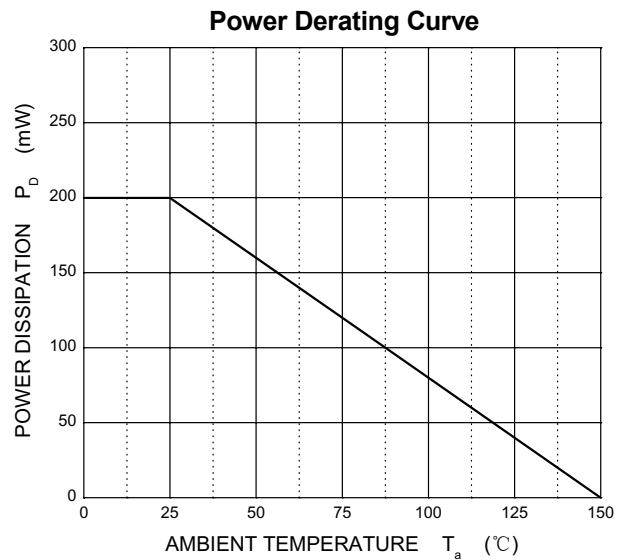
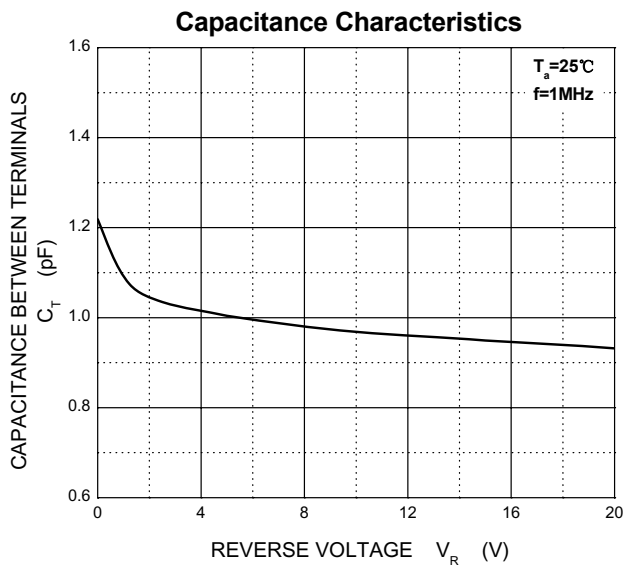
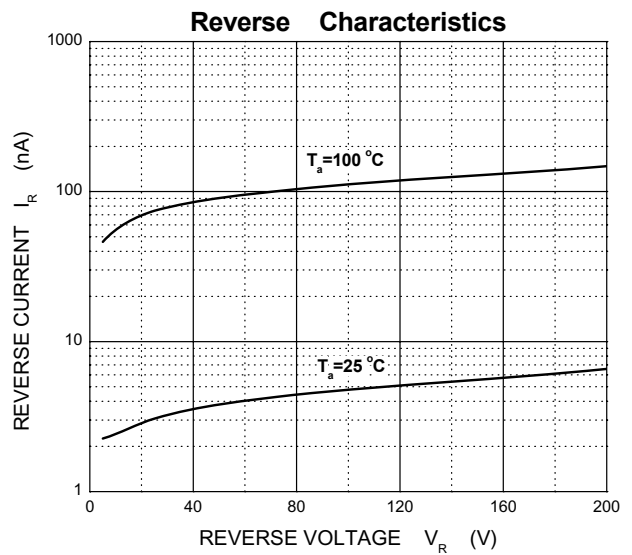
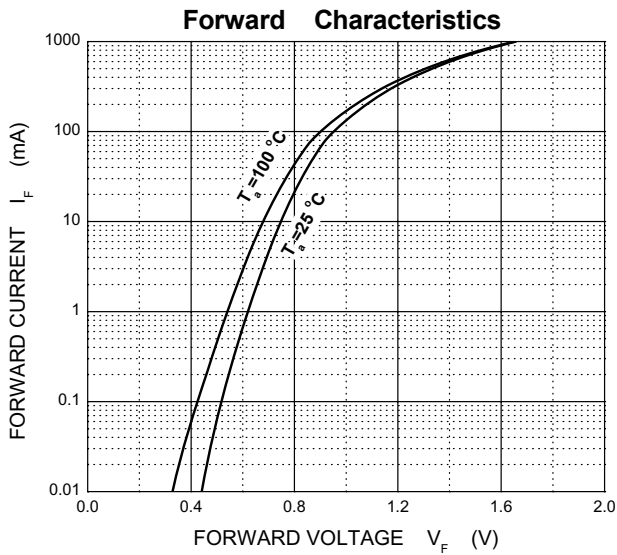

BAS21WS

MOUNTING PAD LAYOUT

SOD-323

Unit:Inch(mm)

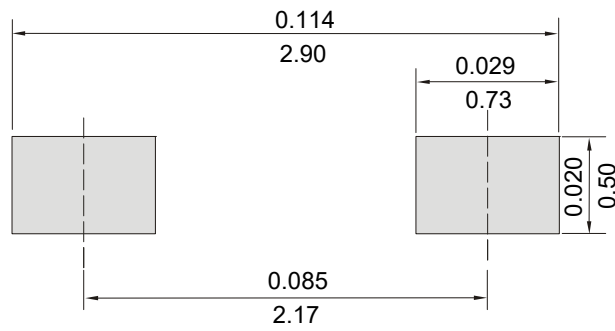

ORDER INFORMATION

- Packing information

| Part Number | Case | Reel Size | QUANTITY |
|-------------|---------|-----------|----------|
| BAS21WS | SOD-323 | 7 Inch | 3000 |