

MUR605FCT~MUR660FCT

SUPERFAST RECOVERY RECTIFIER

VOLTAGE 50 to 600 Volt **CURRENT** 6.0 Ampere

ITO-220AB Unit:mm

FEATURES

- Superfast recovery times-epitaxial construction.
- Low forward voltage, high current capability.
- Low leakage.
- High surge capability.
- Lead free in compliance with EU RoHS

MECHANICAL DATA

- Case Material: Molded Plastic.
- UL Flammability Classification Rating 94V-0

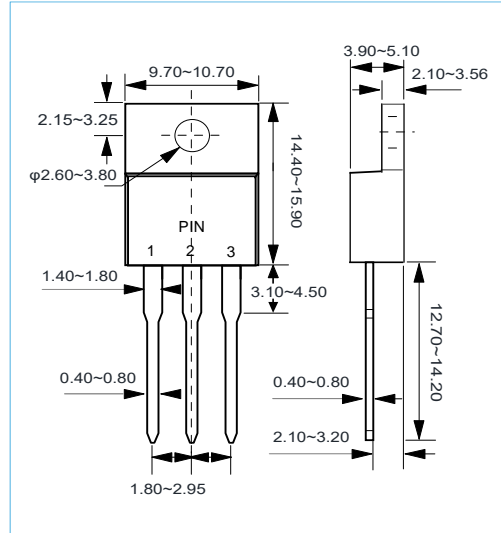
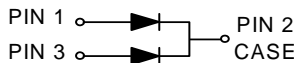

MAXIMUM RATINGS AND ELECTRICAL CHARACTERISTICS

Ratings at 25°C ambient temperature unless otherwise specified.

PARAMETER	SYMBOL	MUR605FCT	MUR610FCT	MUR620FCT	MUR640FCT	MUR660FCT	UNITS
Maximum Recurrent Peak Reverse Voltage	V_{RRM}	50	100	200	400	600	V
Maximum RMS Voltage	V_{RMS}	35	70	140	280	420	V
Maximum DC Blocking Voltage	V_{DC}	50	100	200	400	600	V
Maximum Average Forward Current at See Fig 1	$I_{F(AV)}$	6					A
Peak Forward Surge Current, 8.3ms single half sine-wave superimposed on rated load	I_{FSM}	80					A
Maximum Forward Voltage at 3 A (Note 1)	V_F	0.975			1.3	1.7	V
Maximum DC Reverse Current at Rated DC Blocking Voltage $T_J=25^{\circ}C$ $T_J=100^{\circ}C$	I_R	5 50					μA
Maximum Reverse Recovery Time (Note 1)	t_{rr}			35	60	75	ns
Typical Junction Capacitance (Note 2)	C_J	60					pF
Typical thermal Resistance (Note 3)	$R_{\theta JC}$	3					$^{\circ}C / W$
Operating Junction and Storage Temperature Range	T_J, T_{STG}	-55 to +150					$^{\circ}C$

NOTES:

1. Pulse Test with PW=300 μ sec, 2% Duty Cycle.
2. Reverse Recovery Tset Conditions : $I_F=0.5A, I_R=1A, I_{rr}=0.25A$
3. Mounted on P.C. Board with 14mm² (0.013mm thick) copper pad areas.

MUR605FCT~MUR660FCT

RATING AND CHARACTERISTIC CURVES

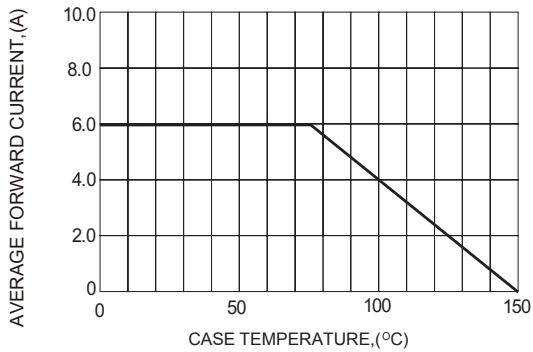

Fig. 1 Forward Current Derating Curve

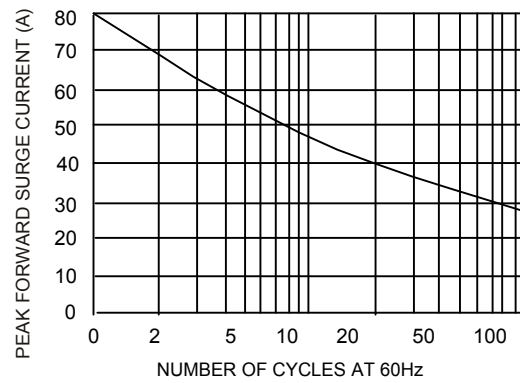

Fig. 2 Surge Current Derating Curve

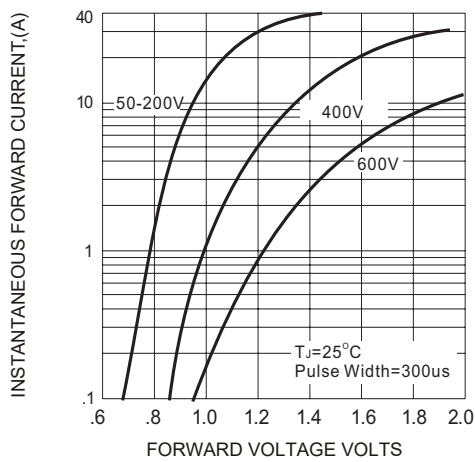

Fig. 3 Typical Forward Characteristics

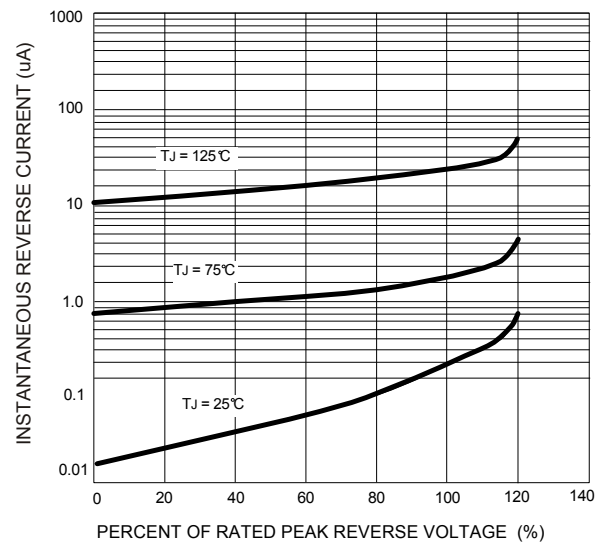
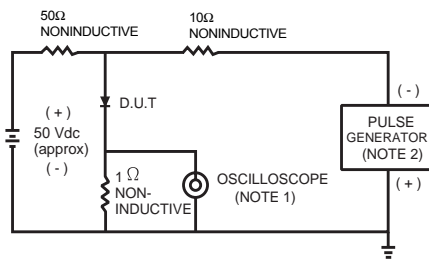

Fig. 4 Typical Reverse Characteristics



NOTES:
 3. Rise time = 7.0 ns max; Input impedance = 1.0 megaohm 22 pf.
 4. Rise time = 10 ns max; Source impedance = 50 ohms.

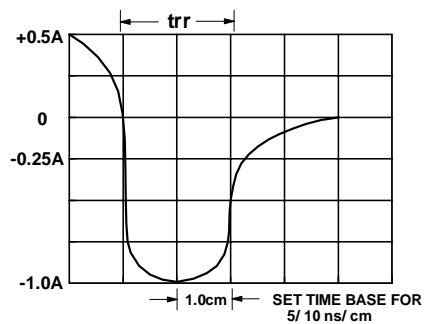

Fig. 5 Reverse Recovery Time Characteristic and Test Circuit

MUR605FCT~MUR660FCT

ORDER INFORMATION

- Packing information

Part Number	Case	DELIVERY MODE	QUANTITY
MUR605FCT~MUR660FCT	ITO-220AB	Tube	1000/BOX