

GESK5VD3

ESD Protection Diode

VOLTAGE 5 Volt

FEATURES

- Uni-directional ESD protection of one line
- Low reverse clamping voltage
- Low leakage current
- IEC 61000-4-2 ±25KV air ,±25KV contact
- Lead free in compliance with EU RoHS

MECHANICAL DATA

- Case Material: Molded Plastic.
- UL Flammability Classification Rating 94V-0

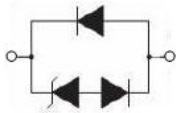

Schematic Diagram

SOD-323

Unit:mm

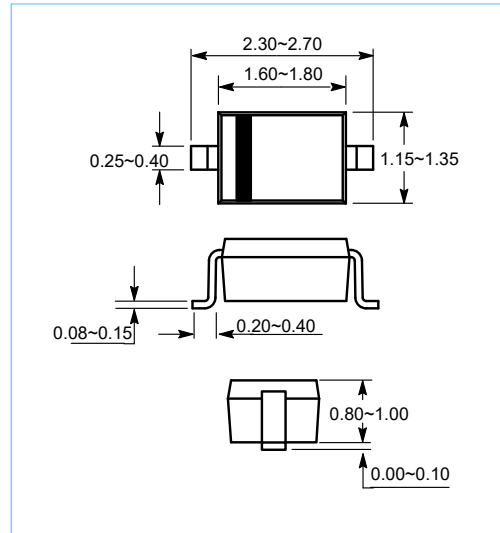

ABSOLUTE MAXIMUM RATINGS($T_A = 25^\circ\text{C}$ unless otherwise noted)

Parameter	Symbol	Limit	Unit
JESD22-A114-B ESD Voltage	$V_{\text{ESD}}^{(1)}$	±16	kV
ESD Voltage		±0.4	
Peak Pulse Power	$P_{\text{PP}}^{(2)}$	750	W
Peak Pulse Current	$I_{\text{PP}}^{(2)}$	30	A
Junction Temperature	T_j	150	°C
Storage Temperature Range	T_{stg}	-55 ~ +150	°C

(1).Device stressed with ten non-repetitive ESD pulses.

(2).Non-repetitive current pulse 8/20μs exponential decay waveform according to IEC61000-4-5.

GESK5VD3

ELECTRICAL PARAMETER

Symbol	Parameter
V_C	Clamping Voltage @ I_{PP}
I_{PP}	Peak Pulse Current
V_{BR}	Breakdown Voltage @ I_T
I_T	Test Current
I_R	Reverse Leakage Current @ V_{RWM}
V_{RWM}	Reverse Standoff Voltage
V_F	Forward Voltage@ I_F
I_F	Forward Current

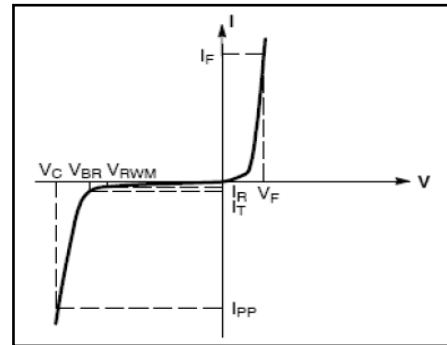

V-I characteristics for a uni-directional TVS

ELECTRICAL CHARACTERISTICS($T_A = 25^\circ\text{C}$ unless otherwise noted)

Parameter	mbol	Test conditions	Min	Typ	Max	Unit
Reverse stand off voltage	$V_{RWM}^{(3)}$				5	V
Reverse leakage current	I_R	$V_{RWM}=5V$			1	μA
Breakdown voltage	$V_{(BR)}$	$I_T=1\text{mA}$	6		8	V
Clamping voltage	$V_C^{(4)}$	$I_{PP}=30\text{A}$			27	V
Junction capacitance	C_J	$V_R=0V, f=1\text{MHz}$			2	pF

(3).Other voltages available upon request.

(4).Non-repetitive current pulse 8/20 μs exponential decay waveform according to IEC61000-4-5

GESK5VD3

Typical Characteristics

Forward Characteristics

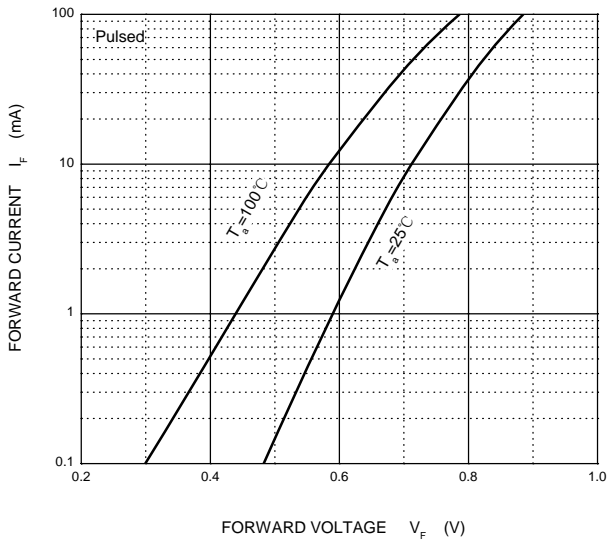

Reverse Characteristics

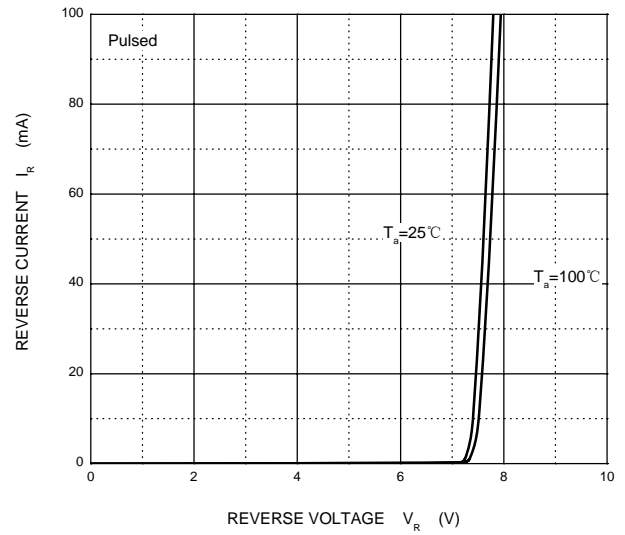

V_C — I_{PP}

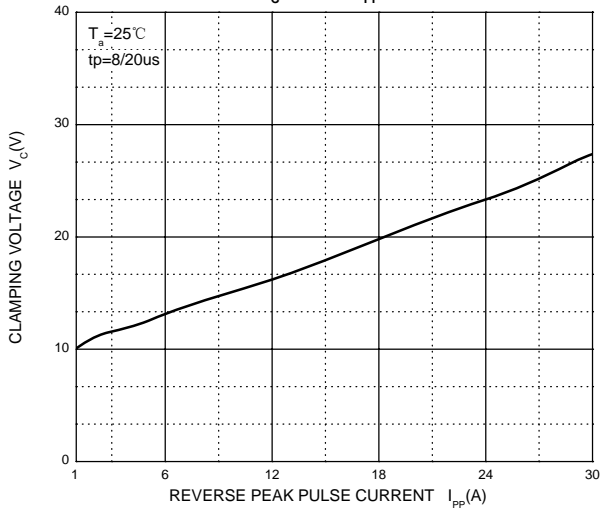

Capacitance Characteristics

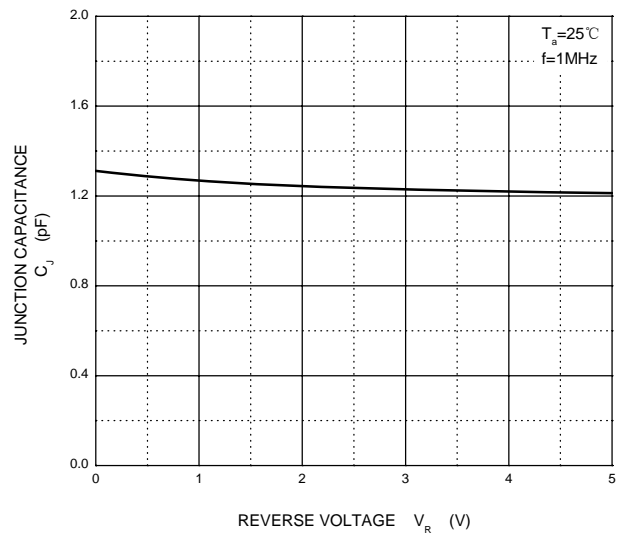

GESK5VD3

MOUNTING PAD LAYOUT

SOD-323

Unit: Inch(mm)

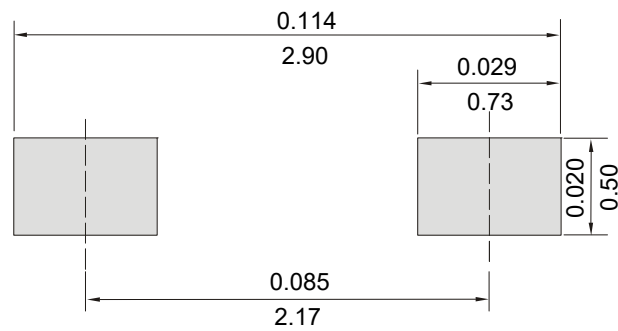

ORDER INFORMATION

- Packing information

Part Number	Case	Reel Size	QUANTITY
GESK5VD3	SOD-323	7 Inch	3000