

LS4150

FAST SWITCHING SURFACE MOUNT DIODES

VOLTAGE
50 Volts
POWER
500 mWatts
QUADRO-MELF

Unit : inch(mm)

FEATURES

- Fast switching Speed.
- Surface Mount Package Ideally Suited For Automatic Insertion.
- Silicon Epitaxial Planar Construction.
- Lead free in comply with EU RoHS 2002/95/EC directives

MECHANICAL DATA

- Case: QUADRO Melf, Glass
- Terminals: Solderable per MIL-STD-750, Method 2026
- Polarity: Cathode Band
- Marking: Cathode Band Only

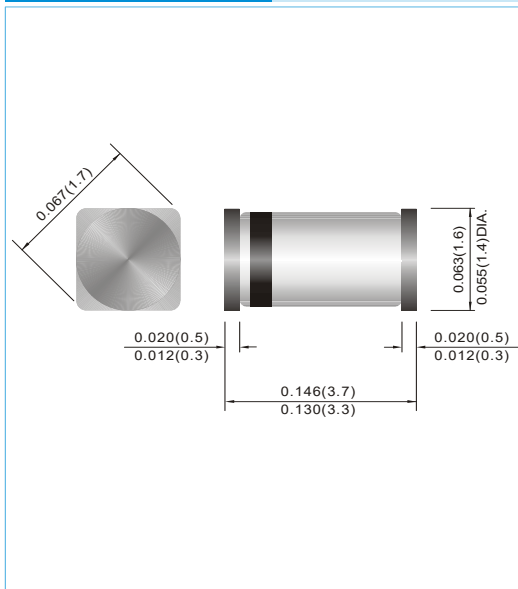
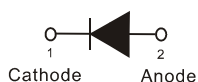

MAXIMUM RATINGS AND ELECTRICAL CHARACTERISTICS (TA=25°C unless otherwise noted)

| PARAMETER | SYMBOL | LS4150 | UNITS |
|--|-----------------|-------------|-----------------------------|
| Reverse Voltage | V_R | 50 | V |
| Peak Reverse Voltage | V_{RM} | 50 | V |
| RMS Voltage | V_{RMS} | 35 | V |
| Maximum Average Forward Current at $T_A=25^\circ\text{C}$ And $f \geq 50\text{Hz}$ | $I_{F(AV)}$ | 200 | mA |
| Surge Forward Current at $t < 1\text{s}$ and $T_J=25^\circ\text{C}$ | I_{FSM} | 500 | mA |
| Power Dissipation at $T_{amb}= 25^\circ\text{C}$ | P_{TOT} | 500 | mW |
| Maximum Forward Voltage at $I_F=200\text{mA}$ | V_F | 1.0 | V |
| Maximum Leakage Current at $V_R= 50\text{V}$ | I_R | 0.1 | μA |
| Maximum Capacitance (Note 1) | C_J | 4 | pF |
| Maximum Reverse Recovery Time (Note 2) | t_{rr} | 4 | ns |
| Typical Thermal Resistance | $R_{\theta JA}$ | 350 | $^\circ\text{C} / \text{W}$ |
| Junction Temperature and Storage Temperature Range | T_J, T_S | -65 to +175 | $^\circ\text{C}$ |

NOTE:

1. C_J at $V_R=0$, $f=1\text{MHZ}$
2. From $I_F=10\text{mA}$ to $I_R=1\text{mA}$, $V_R=6\text{Volts}$, $R_L=100\Omega$

LS4150

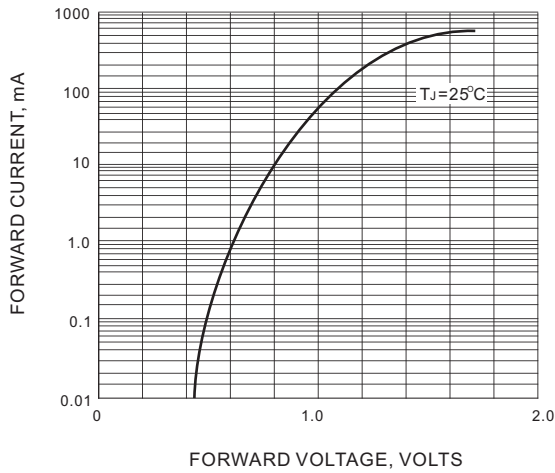

FORWARD VOLTAGE

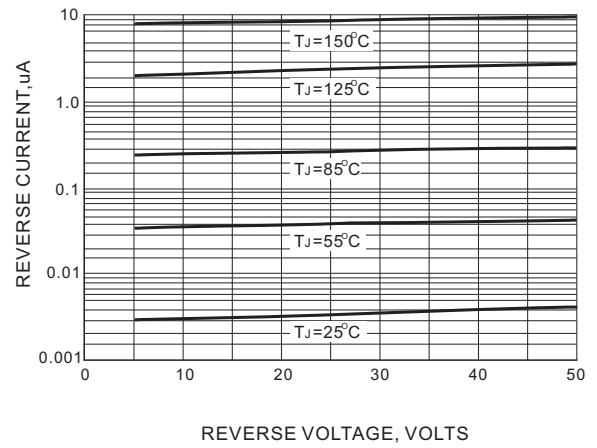

LEAKAGE CURRENT

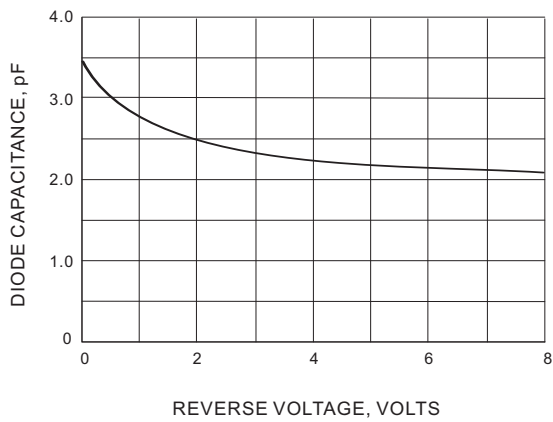

TYPICAL CAPATICANCE

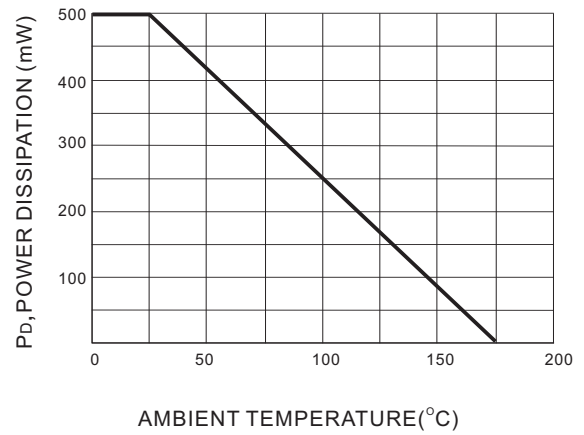

POWER DERATING

LS4150

MOUNTING PAD LAYOUT

QUADRO-MELF

Unit: inch (mm)

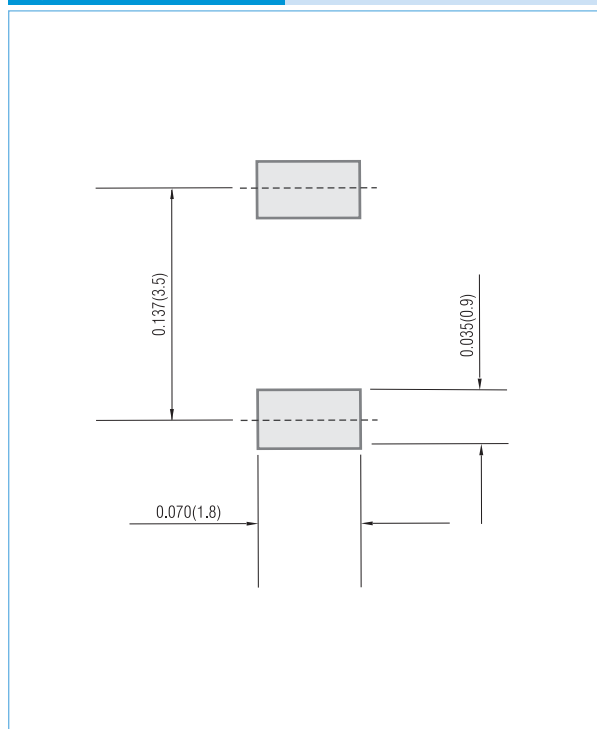

ORDER INFORMATION

- Packing information

T/R - 10K per 13" plastic Reel

T/R - 2.5K per 7" plastic Reel

LS4150

Part No_packing code_Version

LS4150_R1_10001

LS4150_R2_10001

For example :

RB500V-40_R2_00001

Part No.

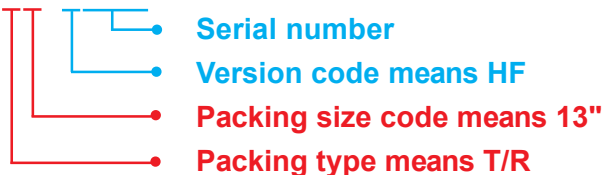

| Packing Code XX | | | | Version Code XXXXX | | |
|--------------------------------------|----------------------|----------------------------------|----------------------|---------------------------|----------------------|---------------------------------------|
| Packing type | 1 st Code | Packing size code | 2 nd Code | HF or RoHS | 1 st Code | 2 nd ~5 th Code |
| Tape and Ammunition Box (T/B) | A | N/A | 0 | HF | 0 | serial number |
| Tape and Reel (T/R) | R | 7" | 1 | RoHS | 1 | serial number |
| Bulk Packing (B/P) | B | 13" | 2 | | | |
| Tube Packing (T/P) | T | 26mm | X | | | |
| Tape and Reel (Right Oriented) (TRR) | S | 52mm | Y | | | |
| Tape and Reel (Left Oriented) (TRL) | L | PANASERT T/B CATHODE UP (PBCU) | U | | | |
| FORMING | F | PANASERT T/B CATHODE DOWN (PBCD) | D | | | |

LS4150

Disclaimer

- Reproducing and modifying information of the document is prohibited without permission from Siyang Grande Electronics Co., Ltd..
- Siyang Grande Electronics Co., Ltd. reserves the rights to make changes of the content herein the document anytime without notification. Please refer to our website for the latest document.
- Siyang Grande Electronics Co., Ltd. disclaims any and all liability arising out of the application or use of any product including damages incidentally and consequentially occurred.
- Siyang Grande Electronics Co., Ltd. does not assume any and all implied warranties, including warranties of fitness for particular purpose, non-infringement and merchantability.
- Applications shown on the herein document are examples of standard use and operation. Customers are responsible in comprehending the suitable use in particular applications. Siyang Grande Electronics Co., Ltd. makes no representation or warranty that such applications will be suitable for the specified use without further testing or modification.
- The products shown herein are not designed and authorized for equipments requiring high level of reliability or relating to human life and for any applications concerning life-saving or life-sustaining, such as medical instruments, transportation equipment, aerospace machinery et cetera. Customers using or selling these products for use in such applications do so at their own risk and agree to fully indemnify Siyang Grande Electronics Co., Ltd. for any damages resulting from such improper use or sale.
- Since Grande uses lot number as the tracking base, please provide the lot number for tracking when complaining.