

LL4151

FAST SWITCHING SURFACE MOUNT DIODES

VOLTAGE 50 Volts **POWER** 500 mWatts

MINI-MELF/LL-34 Unit : inch (mm)

FEATURES

- Fast switching Speed.
- Surface Mount Package Ideally Suited For Automatic Insertion.
- Silicon Epitaxial Planar Construction.
- In compliance with EU RoHS 2002/95/EC directives

MECHANICAL DATA

- Case: Mini Melf, Glass
- Terminals: Solderable per MIL-STD-750, Method 2026
- Polarity: Cathode Band
- Marking: Cathode Band Only

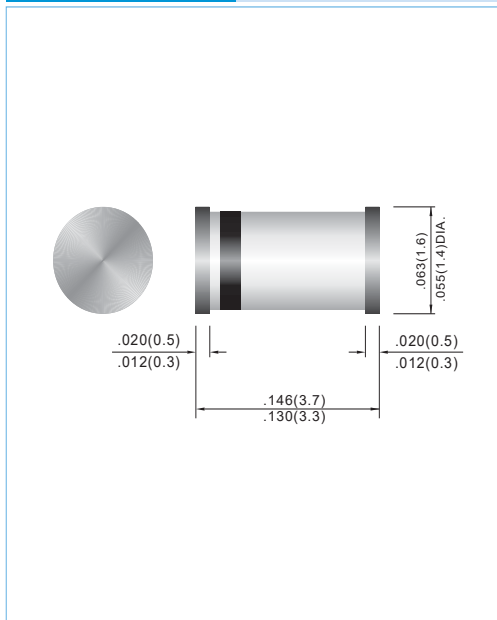
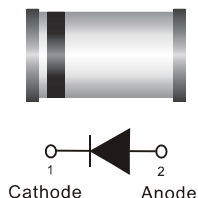

MAXIMUM RATINGS AND ELECTRICAL CHARACTERISTICS (TA=25°C unless otherwise noted)

PARAMETER	SYMBOL	LL4151	UNITS
Reverse Voltage	V_R	50	V
Peak Reverse Voltage	V_{RM}	75	V
Maximum Average Forward Current at $T_A=25^\circ\text{C}$ And $f \geq 50\text{Hz}$	$I_{F(AV)}$	150	mA
Surge Forward Current at $t < 1\text{s}$ and $T_J=25^\circ\text{C}$	I_{FSM}	500	mA
Power Dissipation at $T_{amb}=25^\circ\text{C}$	P_{TOT}	500	mW
Maximum Forward Voltage at $I_F=50\text{mA}$	V_F	1.0	V
Maximum Leakage Current at $V_R=50\text{V}$	I_R	0.05	μA
Maximum Capacitance (Note 1)	C_J	2	pF
Maximum Reverse Recovery Time (Note 2)	t_{tr}	2	ns
Typical Thermal Resistance	$R_{\theta JA}$	350	$^\circ\text{C} / \text{W}$
Junction Temperature and Storage Temperature Range	T_J, T_S	-65 to +175	$^\circ\text{C}$

NOTE:

1. C_J at $V_R=0$, $f=1\text{MHz}$
2. From $I_F=10\text{mA}$ to $I_R=1\text{mA}$, $V_R=6\text{Volts}$, $R_L=100\Omega$

LL4151

Characteristics ($T_j = 25^\circ\text{C}$ unless otherwise specified)

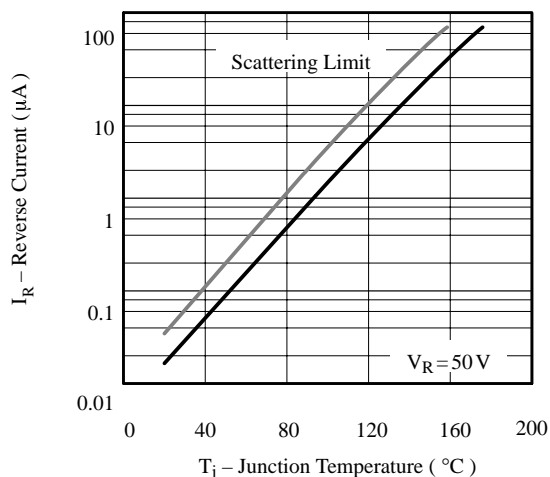

Figure 1. Reverse Current vs. Junction Temperature

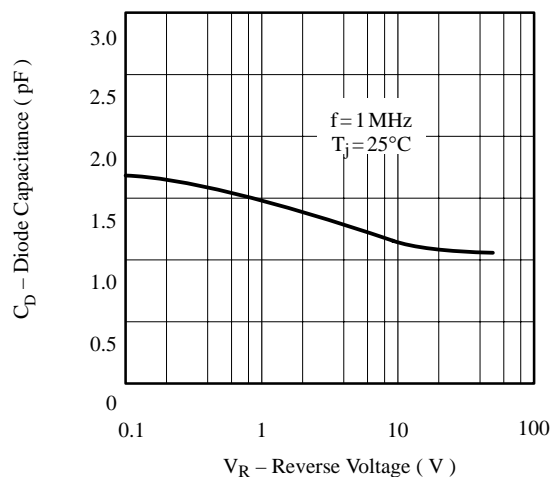

Figure 3. Diode Capacitance vs. Reverse Voltage

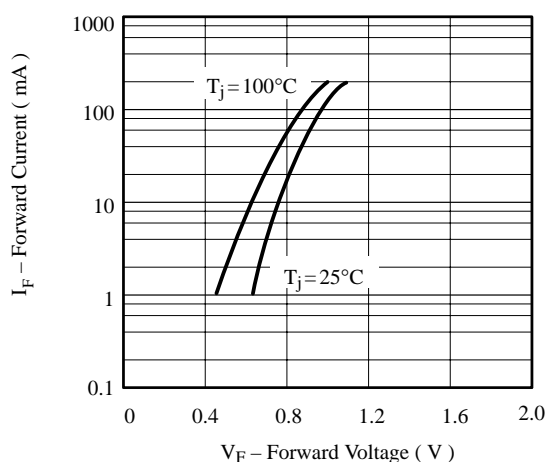
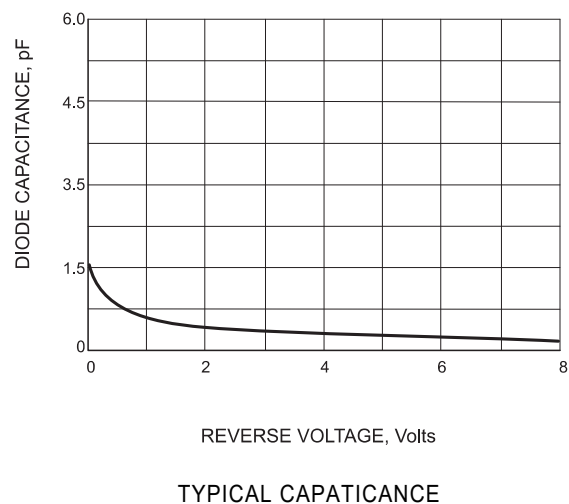
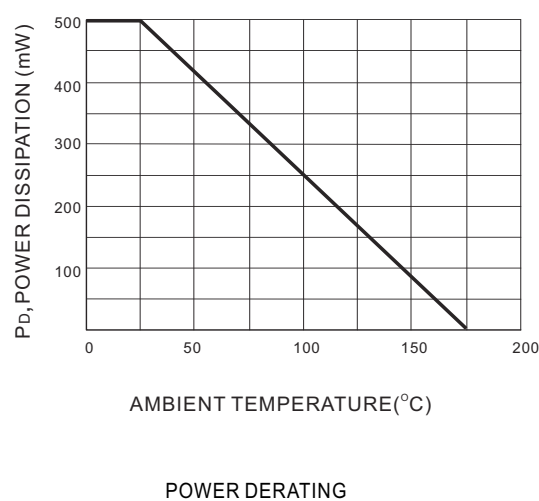

Figure 2. Forward Current vs. Forward Voltage



LL4151

MOUNTING PAD LAYOUT

MINI-MELF

Unit: inch (mm)

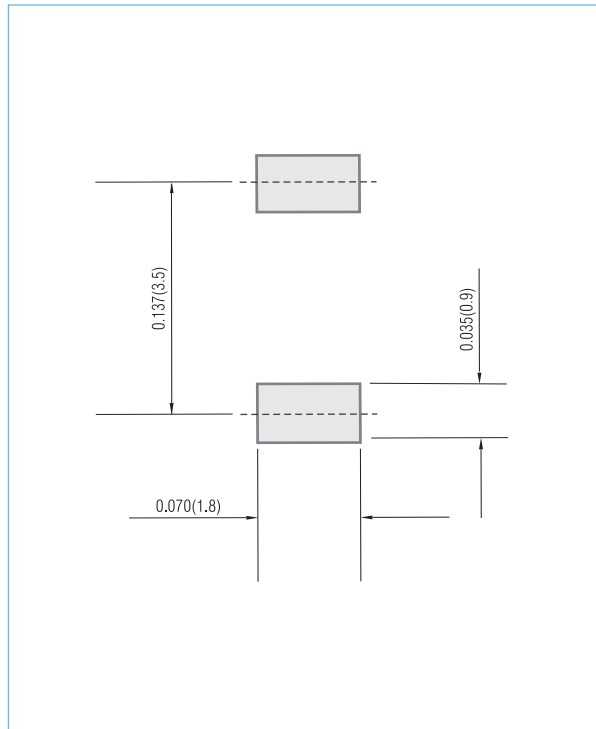

ORDER INFORMATION

- Packing information
 - T/R - 10K per 13" plastic Reel
 - T/R - 2.5K per 7" plastic Reel

LL4151

Part No_packing code_Version

LL4151_R1_10001

LL4151_R2_10001

For example :

RB500V-40 **R2** **00001**

Part No.

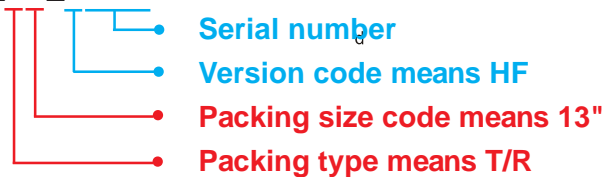

Packing Code XX				Version Code XXXXXX		
Packing type	1 st Code	Packing size code	2 nd Code	HF or RoHS	1 st Code	2 nd ~5 th Code
Tape and Ammunition Box (T/B)	A	N/A	0	HF	0	serial number
Tape and Reel (T/R)	R	7"	1	RoHS	1	serial number
Bulk Packing (B/P)	B	13"	2			
Tube Packing (T/P)	T	26mm	X			
Tape and Reel (Right Oriented) (TRR)	S	52mm	Y			
Tape and Reel (Left Oriented) (TRL)	L	PANASERT T/B CATHODE UP (PBCU)	U			
FORMING	F	PANASERT T/B CATHODE DOWN (PBCD)	D			

LL4151

Disclaimer

- Reproducing and modifying information of the document is prohibited without permission from Siyang Grande Electronics Co., Ltd..
- Siyang Grande Electronics Co., Ltd. reserves the rights to make changes of the content herein the document anytime without notification. Please refer to our website for the latest document.
- Siyang Grande Electronics Co., Ltd. disclaims any and all liability arising out of the application or use of any product including damages incidentally and consequentially occurred.
- Siyang Grande Electronics Co., Ltd. does not assume any and all implied warranties, including warranties of fitness for particular purpose, non-infringement and merchantability.
- Applications shown on the herein document are examples of standard use and operation. Customers are responsible in comprehending the suitable use in particular applications. Siyang Grande Electronics Co., Ltd. makes no representation or warranty that such applications will be suitable for the specified use without further testing or modification.
- The products shown herein are not designed and authorized for equipments requiring high level of reliability or relating to human life and for any applications concerning life-saving or life-sustaining, such as medical instruments, transportation equipment, aerospace machinery et cetera. Customers using or selling these products for use in such applications do so at their own risk and agree to fully indemnify Siyang Grande Electronics Co., Ltd. for any damages resulting from such improper use or sale.
- Since Grande uses lot number as the tracking base, please provide the lot number for tracking when complaining.