

BAV301~BAV303

HIGH VOLTAGE SURFACE MOUNT SWITCHING DIODES

VOLTAGE 120 to 250 Volts **POWER** 300 mWatts

MICRO-MELF

Unit : inch (mm)

FEATURES

- Fast switching Speed.
- Surface Mount Package Ideally Suited For Automatic Insertion.
- Silicon Epitaxial Planar Construction.
- Lead free in comply with EU RoHS 2011/65/EU directives

MECHANICAL DATA

- Case: Micro Melf, Glass
- Terminals: Solderable per MIL-STD-202E, Method 208
- Polarity: Cathode Band
- Marking: Cathode Band Only

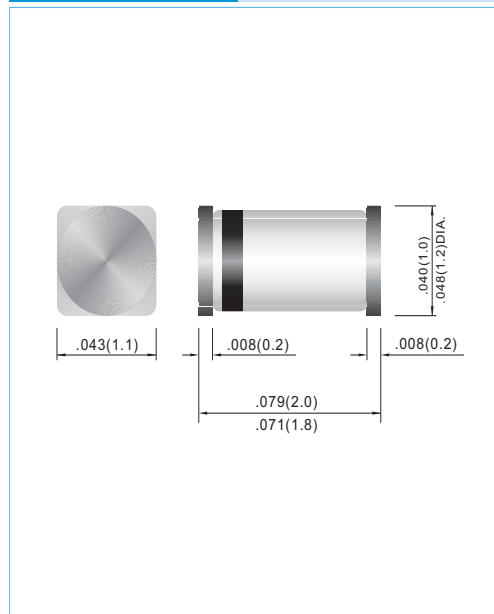
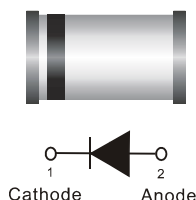

MAXIMUM RATINGS AND ELECTRICAL CHARACTERISTICS (TA=25°C unless otherwise noted)

PARAMETER	SYMBOL	BAV301	BAV302	BAV303	UNITS
Reverse Voltage	V_R	100	150	200	V
Peak Reverse Voltage	V_{RRM}	120	200	250	V
Rectified Current (Average), Half Wave Rectification with Resistive Load and $f \geq 50$ Hz	I_O	200			mA
Peak Forward Surge Current, $t=1000$ ms	I_{FSM}	1.0			A
Power Dissipation Derate Above at 25°C	P_D	300			mW
Maximum Forward Voltage, $I_F = 100$ mA	V_F	1.0			V
Maximum DC Reverse Current at Rated DC Blocking Voltage $T_J = 25^\circ\text{C}$	I_R	0.1			μA
Typical Junction Capacitance(Note 1)	C_J	3.0			pF
Maximum Reverse Recovery (Note 2)	t_{rr}	75			ns
Typical Thermal Resistance	$R_{\theta JA}$	350			$^\circ\text{C} / \text{W}$
Operation Junction Storage Temperature Range	T_{STG}	-65 to +175			$^\circ\text{C}$

NOTE:

1. C_J at $V_R=0$, $f=1$ MHZ
2. From $I_F=10$ mA to $I_R=-1$ mA, $V_R=6$ Volts, $R_L=100\Omega$

BAV301~BAV303

RATING AND CHARACTERISTIC CURVES

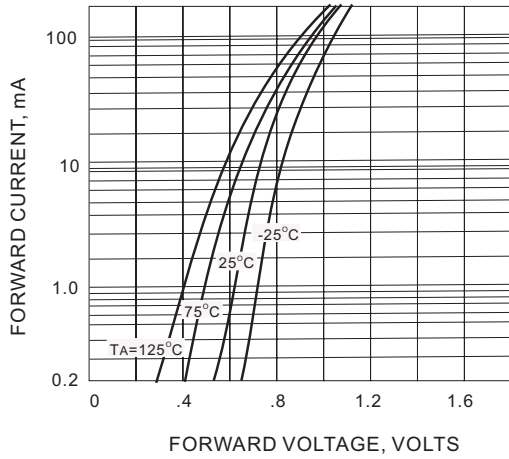

Fig. 1 FORWARD CHARACTERISTICS

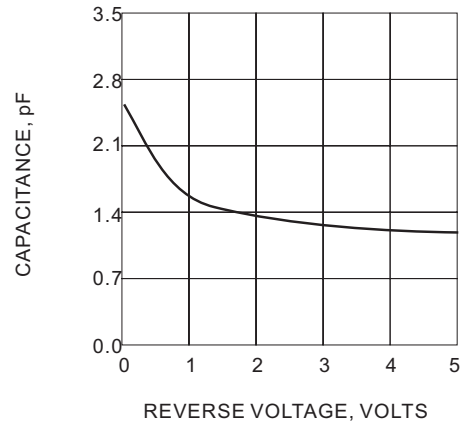

Fig. 2 TYPICAL CAPACITANCE vs REVERSE VOLTAGE

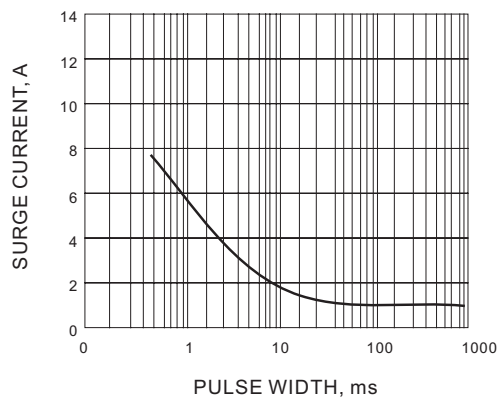

Fig. 3 SURGE CURRENT CHARACTERISTIC

BAV301~BAV303

MOUNTING PAD LAYOUT

MICRO-MELF

Unit: inch (mm)

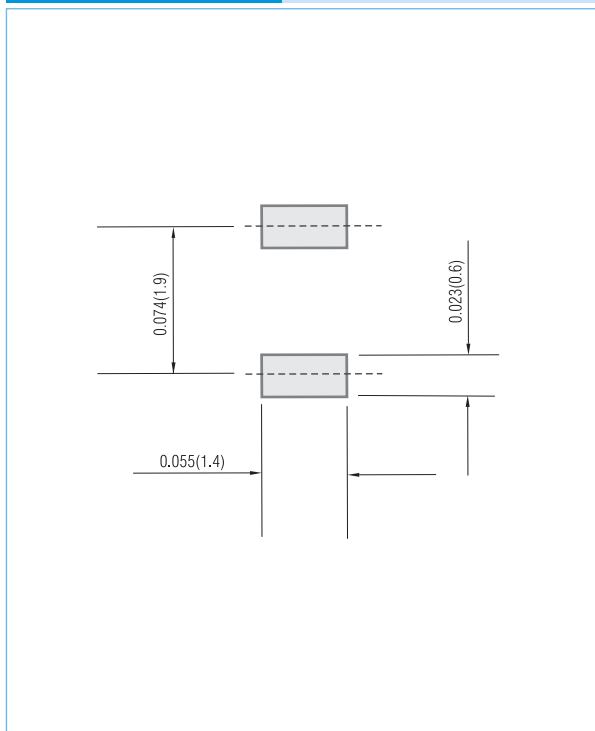

ORDER INFORMATION

- Packing information

T/R - 10K per 13" plastic Reel

T/R - 3K per 7" plastic Reel

BAV301~BAV303

Part No_packing code_Version

BAV301_R1_00001

BAV301_R2_00001

For example :

RB500V-40_R2_00001

Part No.

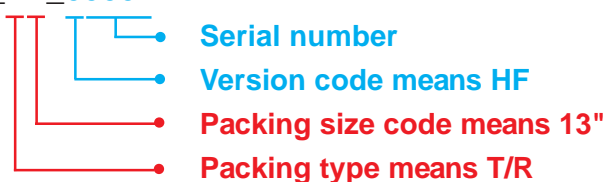

Packing Code XX				Version Code XXXXX		
Packing type	1 st Code	Packing size code	2 nd Code	HF or RoHS	1 st Code	2 nd ~5 th Code
Tape and Ammunition Box (T/B)	A	N/A	0	HF	0	serial number
Tape and Reel (T/R)	R	7"	1	RoHS	1	serial number
Bulk Packing (B/P)	B	13"	2			
Tube Packing (T/P)	T	26mm	X			
Tape and Reel (Right Oriented) (TRR)	S	52mm	Y			
Tape and Reel (Left Oriented) (TRL)	L	PANASERT T/B CATHODE UP (PBCU)	U			
FORMING	F	PANASERT T/B CATHODE DOWN (PBCD)	D			

Disclaimer

- Reproducing and modifying information of the document is prohibited without permission from Siyang Grande Electronics Co., Ltd..
- Siyang Grande Electronics Co., Ltd. reserves the rights to make changes of the content herein the document anytime without notification. Please refer to our website for the latest document.
- Siyang Grande Electronics Co., Ltd. disclaims any and all liability arising out of the application or use of any product including damages incidentally and consequentially occurred.
- Siyang Grande Electronics Co., Ltd. does not assume any and all implied warranties, including warranties of fitness for particular purpose, non-infringement and merchantability.
- Applications shown on the herein document are examples of standard use and operation. Customers are responsible in comprehending the suitable use in particular applications. Siyang Grande Electronics Co., Ltd. makes no representation or warranty that such applications will be suitable for the specified use without further testing or modification.
- The products shown herein are not designed and authorized for equipments requiring high level of reliability or relating to human life and for any applications concerning life-saving or life-sustaining, such as medical instruments, transportation equipment, aerospace machinery et cetera. Customers using or selling these products for use in such applications do so at their own risk and agree to fully indemnify Siyang Grande Electronics Co., Ltd. for any damages resulting from such improper use or sale.
- Since Grande uses lot number as the tracking base, please provide the lot number for tracking when complaining.