

# HER101G~HER107G

## GLASS PASSIVATED JUNCTION ULTRAFAST RECOVERY RECTIFIER

**VOLTAGE** 50 to 1000 Volt **CURRENT** 1.0 Ampere

**DO-41** Unit:mm

### FEATURES

- High efficiency,
- High current capability
- High reliability
- Lead free in compliance with EU RoHS
- Ultra Fast recovery for high efficiency

### MECHANICAL DATA

- Case Material: Molded Plastic.
- UL Flammability Classification Rating 94V-0

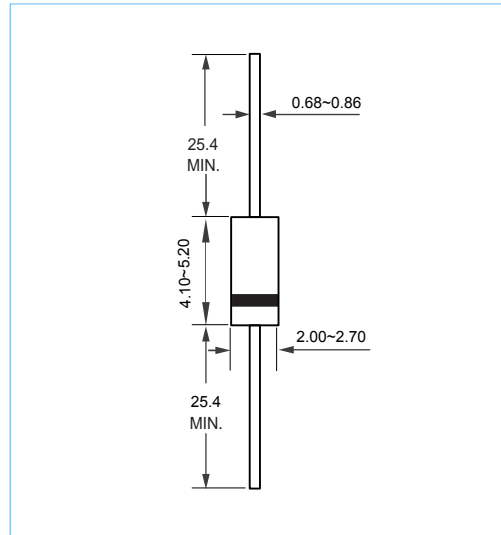
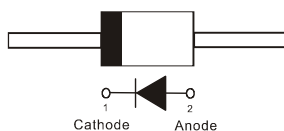

### MAXIMUM RATINGS AND ELECTRICAL CHARACTERISTICS

Ratings at 25°C ambient temperature unless otherwise specified.

PARAMETER	SYMBOL	HER101G	HER102G	HER103G	HER104G	HER105G	HER106G	HER107G	UNITS
Maximum Recurrent Peak Reverse Voltage	$V_{RRM}$	50	100	200	400	600	800	1000	V
Maximum RMS Voltage	$V_{RMS}$	35	70	140	280	420	560	700	V
Maximum DC Blocking Voltage	$V_{DC}$	50	100	200	400	600	800	1000	V
Maximum Average Forward Current (see FIG.1)	$I_{F(AV)}$	1.0							A
Peak Forward Surge Current : 8.3ms single half sine-wave superimposed on rated load(JEDEC method)	$I_{FSM}$	30							A
Maximum Forward Voltage at 1.0A	$V_F$	1.0		1.3		1.7		V	
Maximum DC Reverse Current at Rated DC Blocking Voltage $T_J=25^{\circ}C$ $T_J=100^{\circ}C$	$I_R$	5.0				100			$\mu A$
Typical Junction Capacitance	$C_J$	20				15			pF
Typical Thermal Resistance	$R_{\theta JA}$	60							$^{\circ}C / W$
Maximum Reverse Recovery Time	$t_{rr}$	50				75			ns
Operating Junction and Storage Temperature Range	$T_J, T_{STG}$	-55 to +150							$^{\circ}C$

#### NOTES:

1. Measured at 1 MHz and applied reverse voltage of 4.0 VDC.
2. Thermal Resistance from Junction to Ambient and from Junction to lead length 0.375"(9.5mm) P.C.B. mounted.
3. Reverse Recovery Time  $I_F=0.5A$ ,  $I_R=1A$ ,  $I_{rr}=0.25A$

# HER101G~HER107G

## RATING AND CHARACTERISTIC CURVES

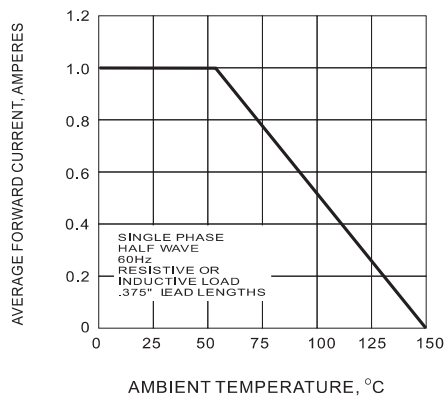

Fig.1 FORWARD CURRENT DERATING CURVE

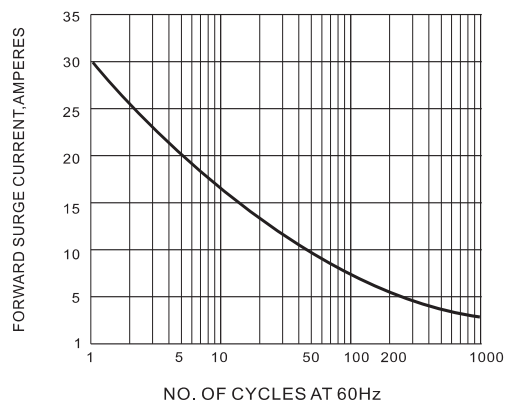

Fig.2 PEAK FORWARD SURGE CURRENT

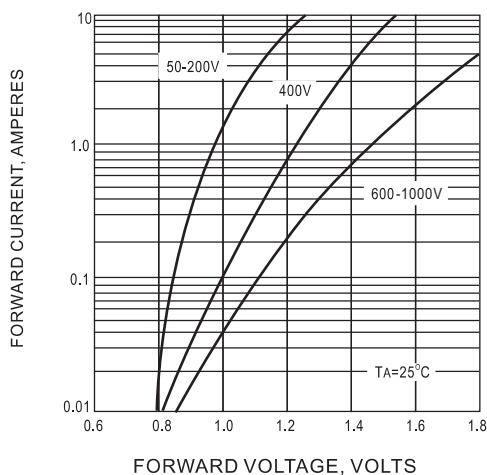

Fig.3 FORWARD CHARACTERISTICS

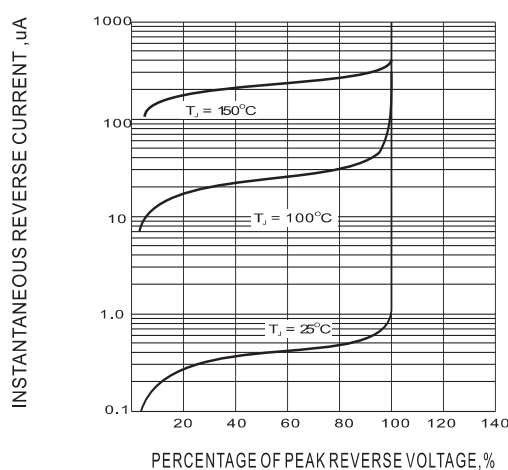

Fig.4 TYPICAL REVERSE CHARACTERISTIC

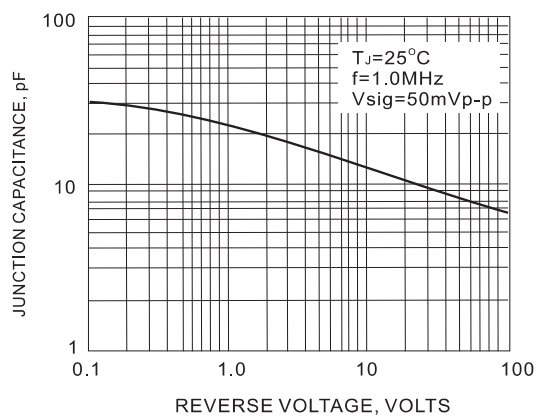

Fig.4 TYPICAL JUNCTION CAPACITANCE

## HER101G~HER107G

---

### Ordering Information

- Packing information

HER101G~HER107G	Packing Quantity
Tape&Reel	13 Inch; 5kpcs/Reel
Ammo Packing	5kpcs/Ammo Box
Bulk(Tube/Box)	1kpcs/Box